

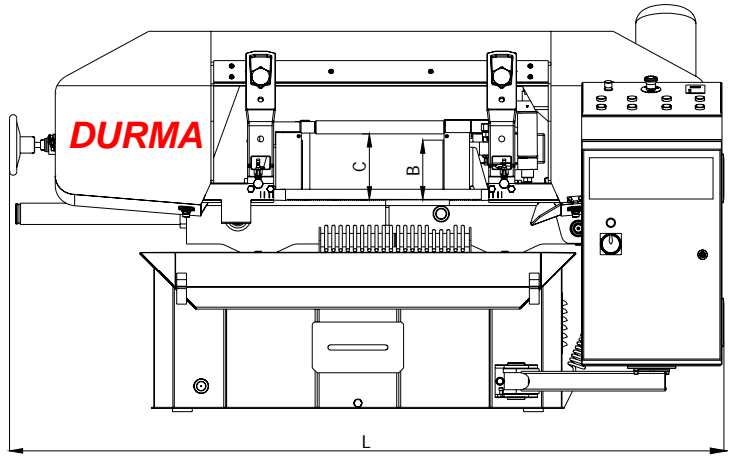

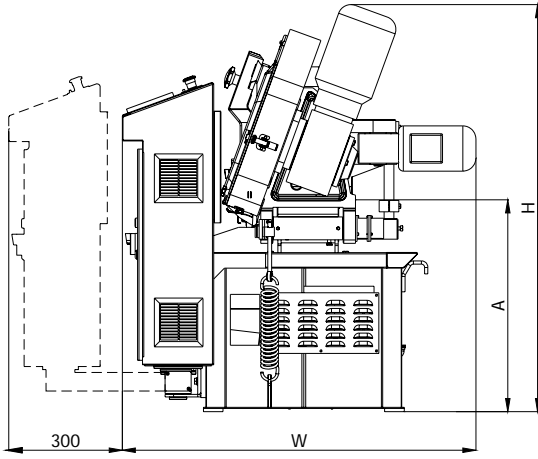









**HB-A 330 TECHNICAL DATA**

**HB-A 330**
**Horizontal Automatic Band Saw**

HB-A 330					Horizontal Automatic Band Saw	
Cutting Capacities	90°		Round	Inch	13"	
			Square	Inch	11¾"	
			Rectangle	Inch	11¾" x 15¾"	
	60°		Round	Inch	-	
			Square	Inch	-	
			Rectangle	Inch	-	
	45°		Round	Inch	-	
			Square	Inch	-	
			Rectangle	Inch	-	
	30°		Round	Inch	-	
			Square	Inch	-	
			Rectangle	Inch	-	
Motor	Main Motor			HP	3	
	Hydraulic Motor			HP	1/2	
	Material Rolling Motor			HP	1/3	
	Cooling Motor			HP	1/8	
Dimensions	Length (L)		Inch	87"		
	Width (W)		Inch	44"		
	Height (H)		Inch	50"		
	Vice Height (B)		Inch	7"		
	Mechanical Top Hold-down Height (C)		Inch	7¾"		
Cutting Speed				Ft/Min	65 ~ 262 Inverter	
Band Size				Inch	1.3" x .04" x 168" (14')	
Working Height (A)		Inch	25½"			
Weight				Lbs.	1,808 Lbs.	
Band Twisting Angle				°	60°	